

General Description

AOT502 uses an optimally designed temperature compensated gate-drain zener clamp. Under overvoltage conditions, the clamp activates and turns on the MOSFET, safely dissipating the energy in the MOSFET. The built in resistor guarantees proper clamp operation under all circuit conditions, and the MOSFET never goes into avalanche breakdown. Advanced trench technology provides excellent low $R_{DS(on)}$, gate charge and body diode characteristics, making this device ideal for motor and inductive load control applications.

Product Summary

V_{DS}	Clamped
I_D (at $V_{GS}=10V$)	60A
$R_{DS(ON)}$ (at $V_{GS}=10V$)	< 11.5m Ω

100% UIS Tested
100% R_g Tested

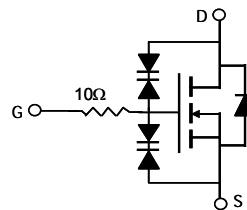
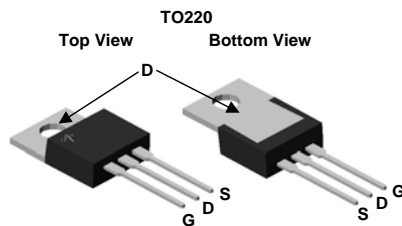

Absolute Maximum Ratings $T_A=25^\circ C$ unless otherwise noted

Parameter	Symbol	Maximum	Units
Drain-Source Voltage	V_{DS}	Clamped	V
Gate-Source Voltage	V_{GS}	Clamped	V
Continuous Drain Current	I_D	$T_C=25^\circ C$	60
		$T_C=100^\circ C$	41
Pulsed Drain Current ^C	I_{DM}	137	A
Continuous Drain Current	I_{DSM}	$T_A=25^\circ C$	9
		$T_A=70^\circ C$	7
Avalanche Current ^C	I_{AS}, I_{AR}	28.5	A
Avalanche energy $L=0.1mH$ ^C	E_{AS}, E_{AR}	41	mJ
Power Dissipation ^B	P_D	$T_C=25^\circ C$	79
		$T_C=100^\circ C$	39
Power Dissipation ^A	P_{DSM}	$T_A=25^\circ C$	1.9
		$T_A=70^\circ C$	1.2
Junction and Storage Temperature Range	T_J, T_{STG}	-55 to 175	$^\circ C$

Thermal Characteristics

Parameter	Symbol	Typ	Max	Units
Maximum Junction-to-Ambient ^A	$R_{\theta JA}$	13	15.6	$^\circ C/W$
Maximum Junction-to-Ambient ^{A D}		Steady-State	54	65
Maximum Junction-to-Case	$R_{\theta JC}$	1.6	1.9	$^\circ C/W$

Electrical Characteristics (T_J=25°C unless otherwise noted)

Symbol	Parameter	Conditions	Min	Typ	Max	Units
STATIC PARAMETERS						
BV _{DSS(z)}	Drain-Source Breakdown Voltage	I _D =10mA, V _{GS} =0V	33			V
BV _{CLAMP}	Drain-Source Clamping Voltage	I _D =1A, V _{GS} =0V	36		44	V
I _{DSS(z)}	Zero Gate Voltage Drain Current	V _{DS} =16V, V _{GS} =0V			20	μA
BV _{GSS}	Gate-Source Voltage	V _{DS} =0V, I _D =250μA	20			V
I _{GSS}	Gate-Body leakage current	V _{DS} =0V, V _{GS} =±10V			10	μA
V _{GS(th)}	Gate Threshold Voltage	V _{DS} =V _{GS} , I _D =250μA	1.6	2.1	2.7	V
I _{D(ON)}	On state drain current	V _{GS} =10V, V _{DS} =5V	137			A
R _{DS(ON)}	Static Drain-Source On-Resistance	V _{GS} =10V, I _D =30A		9.3	11.5	mΩ
		T _J =125°C		15.4	18.5	
g _{FS}	Forward Transconductance	V _{DS} =5V, I _D =30A		55		S
V _{SD}	Diode Forward Voltage	I _S =1A, V _{GS} =0V		0.73	1	V
I _S	Maximum Body-Diode Continuous Current				75	A
DYNAMIC PARAMETERS						
C _{ISS}	Input Capacitance	V _{GS} =0V, V _{DS} =15V, f=1MHz	960	1205	1450	pF
C _{OSS}	Output Capacitance		185	266	345	pF
C _{RSS}	Reverse Transfer Capacitance		65	109	155	pF
R _g	Gate resistance	V _{GS} =0V, V _{DS} =0V, f=1MHz	10	20	30.0	Ω
SWITCHING PARAMETERS						
Q _g	Total Gate Charge	V _{GS} =10V, V _{DS} =15V, I _D =30A	18.5	23.4	28	nC
Q _{gs}	Gate Source Charge		2.7	3.4	4	nC
Q _{gd}	Gate Drain Charge		4	7	10	nC
t _{D(on)}	Turn-On DelayTime	V _{GS} =10V, V _{DS} =15V, R _L =0.5Ω, R _{GEN} =3Ω		13.5		ns
t _r	Turn-On Rise Time			17.5		ns
t _{D(off)}	Turn-Off DelayTime			63		ns
t _f	Turn-Off Fall Time			27		ns
t _{rr}	Body Diode Reverse Recovery Time	I _F =30A, dI/dt=750A/μs	14	17.5	21	ns
Q _{rr}	Body Diode Reverse Recovery Charge	I _F =30A, dI/dt=750A/μs	53.5	67	80	nC

A. The value of R_{θJA} is measured with the device mounted on 1 in² FR-4 board with 2oz. Copper, in a still air environment with T_A=25°C. The Power dissipation P_{DSM} is based on R_{θJA} and the maximum allowed junction temperature of 150°C. The value in any given application depends on the user's specific board design, and the maximum temperature of 175°C may be used if the PCB allows it.

B. The power dissipation P_D is based on T_{J(MAX)}=175°C, using junction-to-case thermal impedance, and is more useful in setting the upper dissipation limit for cases where additional heatsinking is used.

C. Repetitive rating, pulse width limited by junction temperature T_{J(MAX)}=175°C. Ratings are based on low frequency and duty cycles to keep initial T_J=25°C.

D. The R_{θJA} is the sum of the thermal impedance from junction to case R_{θJC} and case to ambient.

E. The static characteristics in Figures 1 to 6 are obtained using <300 μs pulses, duty cycle 0.5% max.

F. These curves are based on the junction-to-case thermal impedance which is measured with the device mounted to a large heatsink, assuming a maximum junction temperature of T_{J(MAX)}=175°C. The SOA curve provides a single pulse rating.

G. These tests are performed with the device mounted on 1 in² FR-4 board with 2oz. Copper, in a still air environment with T_A=25°C.

COMPONENTS IN LIFE SUPPORT DEVICES OR SYSTEMS ARE NOT AUTHORIZED. AOS DOES NOT ASSUME ANY LIABILITY ARISING OUT OF SUCH APPLICATIONS OR USES OF ITS PRODUCTS. AOS RESERVES THE RIGHT TO IMPROVE PRODUCT DESIGN, FUNCTIONS AND RELIABILITY WITHOUT NOTICE.

TYPICAL ELECTRICAL AND THERMAL CHARACTERISTICS

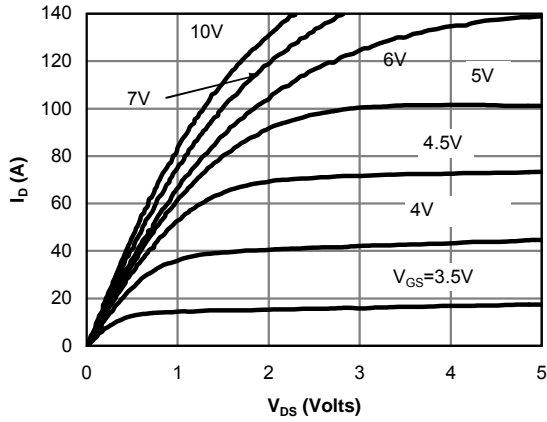

Fig 1: On-Region Characteristics (Note E)

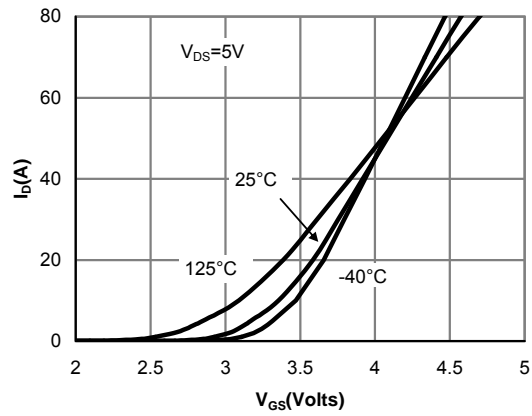

Figure 2: Transfer Characteristics (Note E)

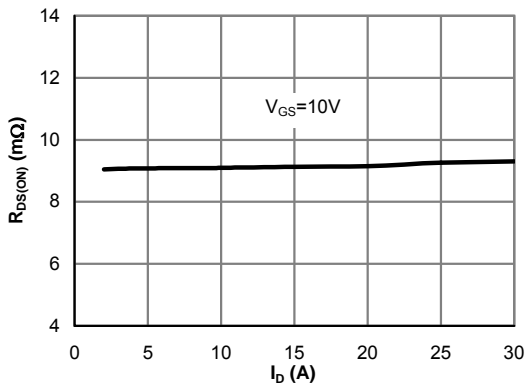

Figure 3: On-Resistance vs. Drain Current and Gate Voltage (Note E)

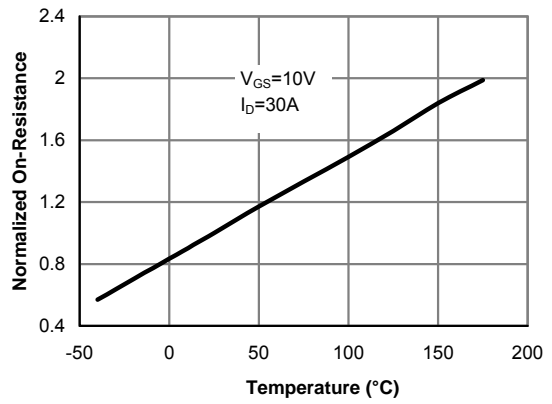

Figure 4: On-Resistance vs. Junction Temperature (Note E)

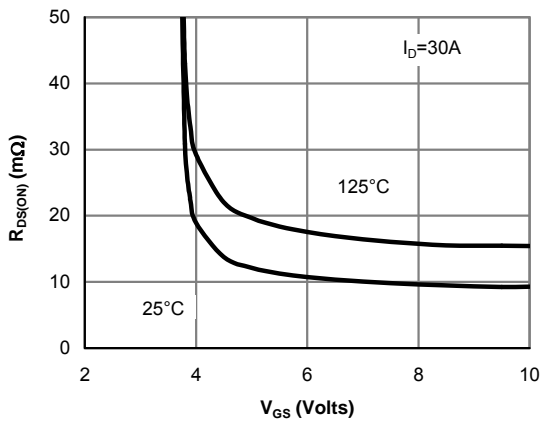

Figure 5: On-Resistance vs. Gate-Source Voltage (Note E)

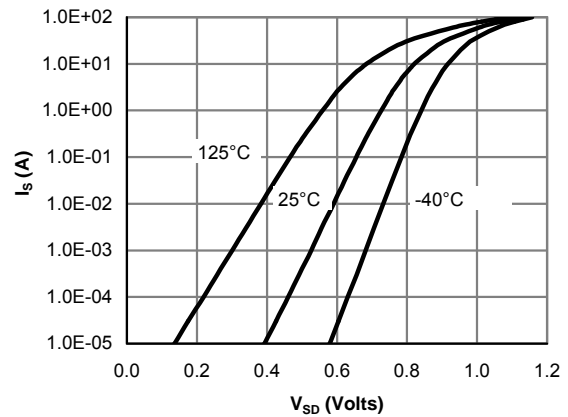

Figure 6: Body-Diode Characteristics (Note E)

TYPICAL ELECTRICAL AND THERMAL CHARACTERISTICS

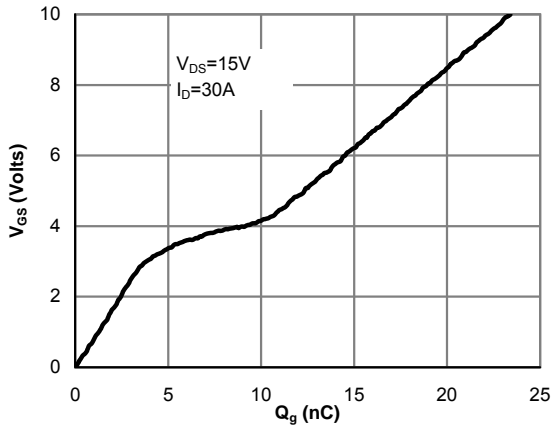

Figure 7: Gate-Charge Characteristics

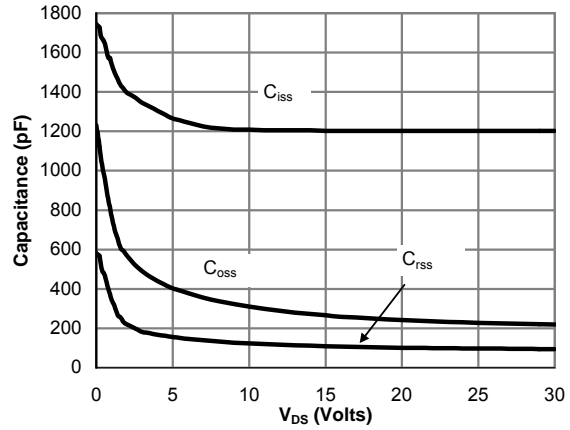

Figure 8: Capacitance Characteristics

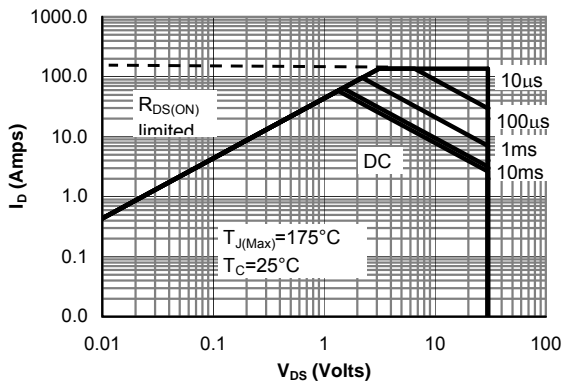

Figure 9: Maximum Forward Biased Safe Operating Area (Note F)

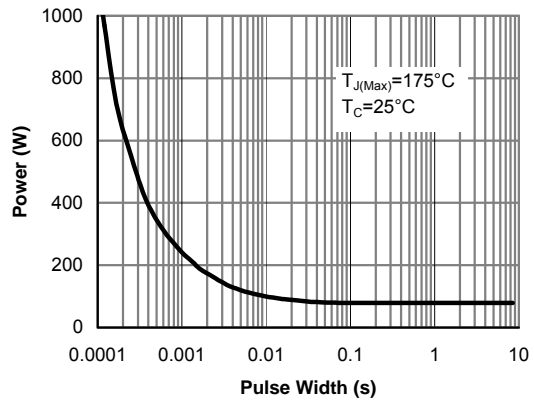

Figure 10: Single Pulse Power Rating Junction-to-Case (Note F)

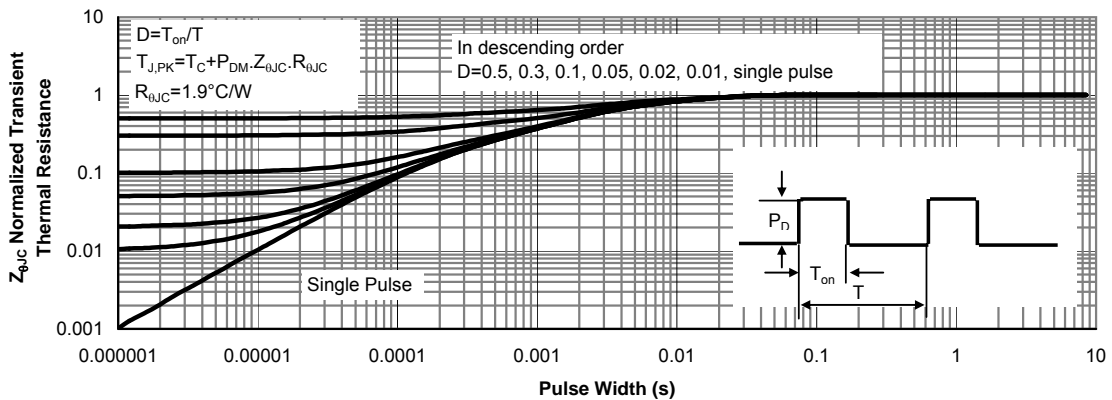

Figure 11: Normalized Maximum Transient Thermal Impedance (Note F)

TYPICAL ELECTRICAL AND THERMAL CHARACTERISTICS

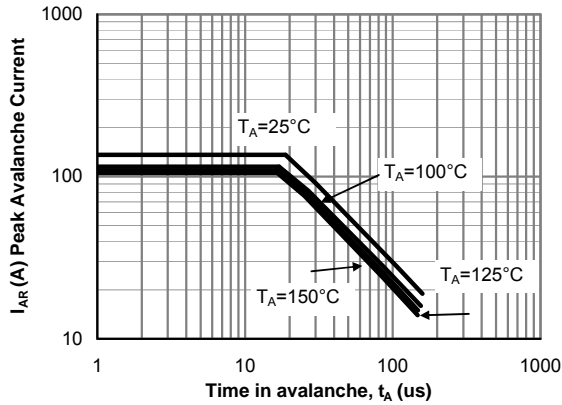

Figure 12: Single Pulse Avalanche capability (Note C)

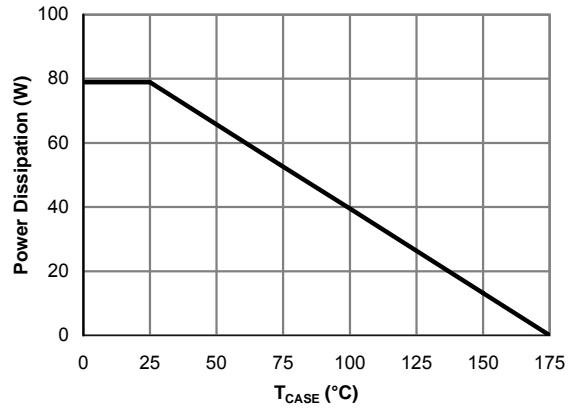

Figure 13: Power De-rating (Note F)

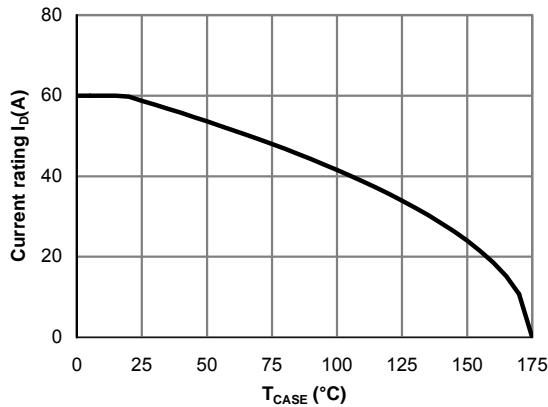

Figure 14: Current De-rating (Note F)

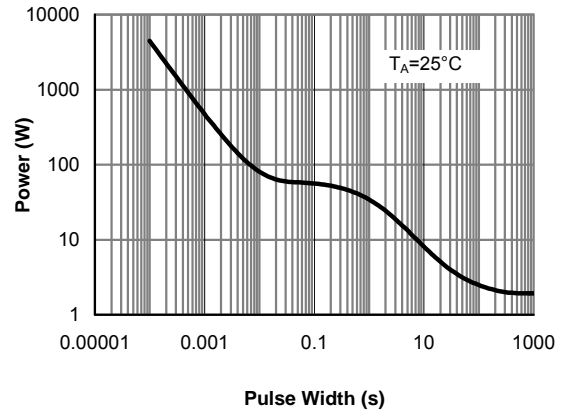

Figure 15: Single Pulse Power Rating Junction-to-Ambient (Note H)

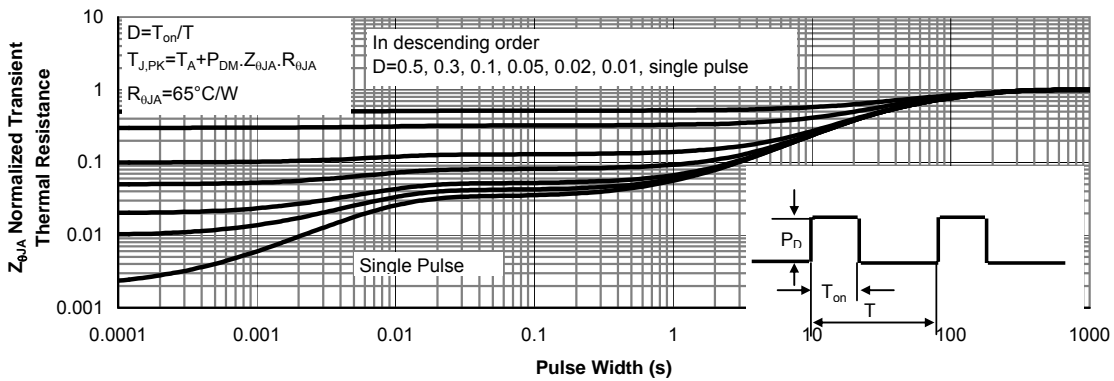

Figure 16: Normalized Maximum Transient Thermal Impedance (Note H)

TYPICAL PROTECTION CHARACTERISTICS

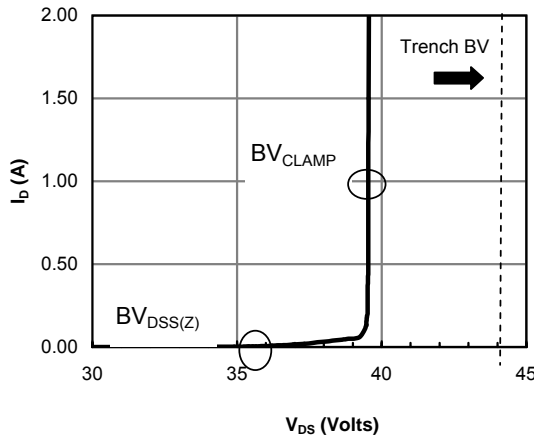

Fig 15: BV_{CLAMP} Characteristic

This device uses built-in Gate to Source and Gate to Drain zener protection. While the Gate-Source zener protects against excessive V_{GS} conditions, the Gate to Drain protection, clamps the V_{DS} well below the device breakdown, preventing an avalanche condition within the MOSFET as a result of voltage over-shoot at the Drain electrode.

It is designed to breakdown well before the device breakdown. During such an event, current flows through the zener clamp, which is situated internally between the Gate to Drain. This current flows at $BV_{DSS(Z)}$, building up the V_{GS} internal to the device. When the current level through the zener reaches approximately 300mA, the V_{GS} is approximately equal to $V_{GS(PLATEAU)}$, allowing significant channel conduction and thus clamping the Drain to Source voltage. The V_{GS} needed to turn the device on is controlled with an internally lumped gate resistor R approximately equal to 10Ω .

$$V_{GS(PLATEAU)} = 10\Omega \times 300mA = 3V$$

It can also be said that the V_{DS} during clamping is equal to:

$$BV_{DSS} = BV_{CLAMP} + V_{GS(PLATEAU)}$$

Additional power loss associated with the protection circuitry can be considered negligible when compare to the conduction losses of the MOSFET itself;

EX:

$$PL = 30\mu A \times 16V = 0.48mW \quad (\text{Zener leakage loss})$$

$$PL(rds) = 10^2 A \times 6m\Omega = 300mW \quad (\text{MOSFET loss})$$

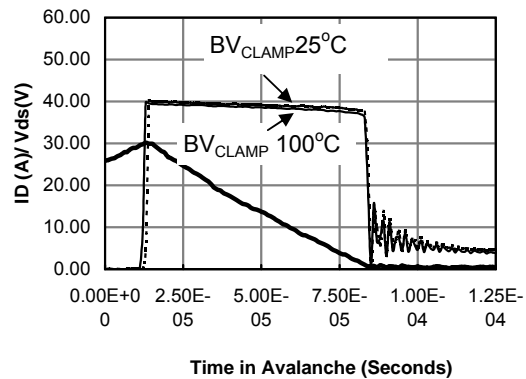
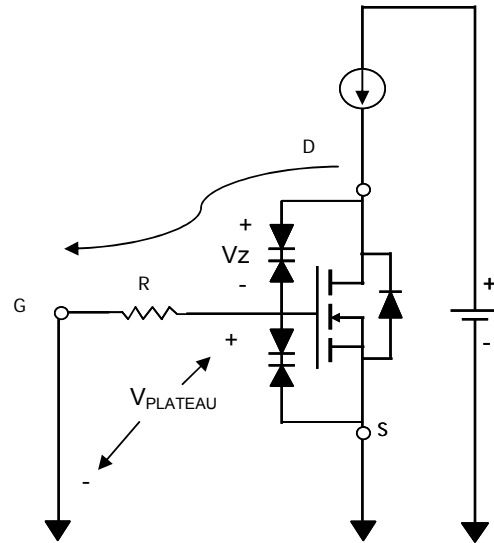
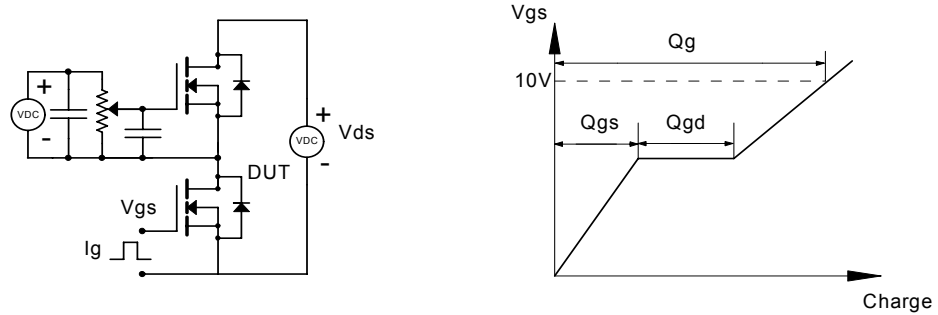

Fig 16: Unclamped Inductive Switching

Fig16: The built-in Gate to Drain clamp prevents the device from going into Avalanche by setting the clamp voltage well below the actual breakdown of the device. When the Drain to Gate voltage approaches the BV clamp, the internal Gate to Source voltage is charged up and channel conduction occurs, sinking the current safely through the device. The BV_{CLAMP} is virtually temperature independent, providing even greater protection during normal operation.

Gate Charge Test Circuit & Waveform



Resistive Switching Test Circuit & Waveforms

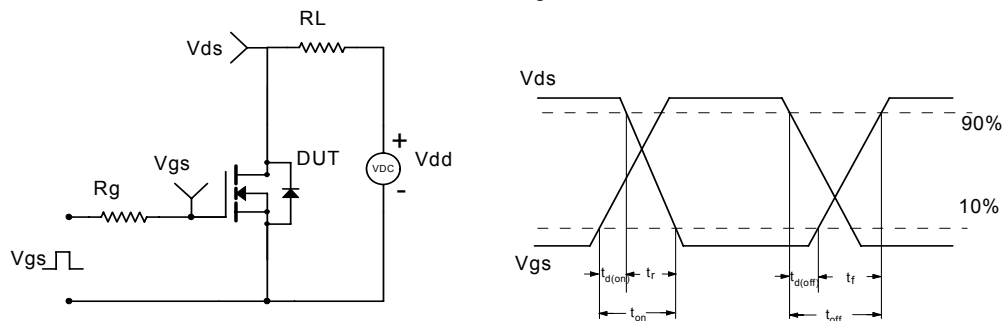

Unclamped Inductive Switching (UIS) Test Circuit & Waveforms

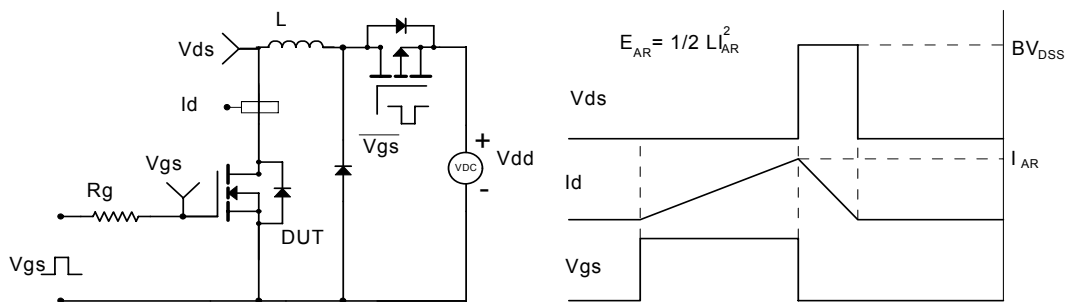

Diode Recovery Test Circuit & Waveforms

